

Proiettore di linee per applicazioni multifunzionali
Line projector for multifunctional applications

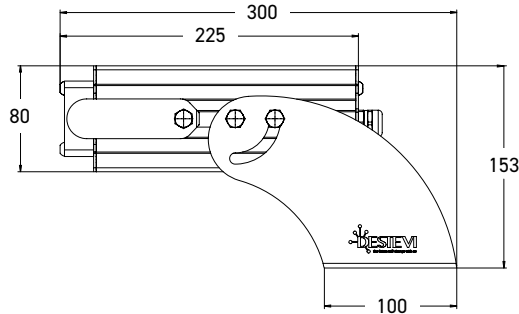

DELAS05CXB-A / DELAS05CYB-A DELAS05CZB-A

Colore BLU
BLUE colour

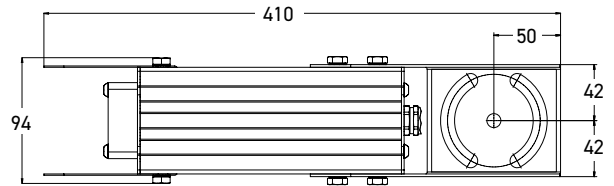
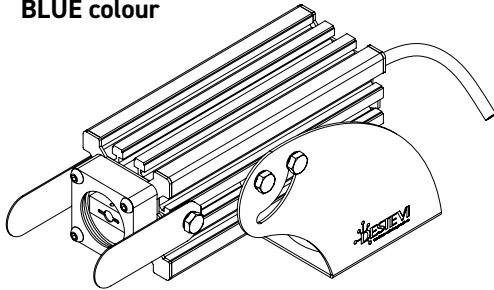

Manuale d'uso e manutenzione
User and maintenance manual



IK09 IP65



SPECIFICHE / SPECIFICATIONS

Potenza Power	16 w	
Tensione alimentazione Supply voltage	85 ~ 305 VAC	120 ~ 430 VDC
Frequenza Frequency	47 ~ 440 Hz	
Tecnologia Technology	Diodo Laser	
Materiale Materials	Alluminio anodizzato e acciaio Inox AISI 304 Anodized aluminium and stainless steel AISI 304	
Temperatura esercizio Operating temperature	- 45° C ~ +65° C	
Fattore di potenza Power factor	> 0,9	
Peso Weight	2,7 kg	
Classificazione Classification	Classe 2M	

APPLICAZIONI / FEATURES

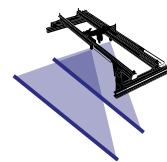

Carriponte
Overhead cranes



Percorsi pedonali
Pedestrian paths

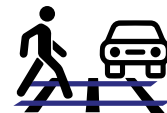

Attraversamenti stradali
Crossings roads



Linee di delimitazione stradale
Road boundary line

Misura di proiezione della linea a terra
Line projection measurement

modello / item

mt

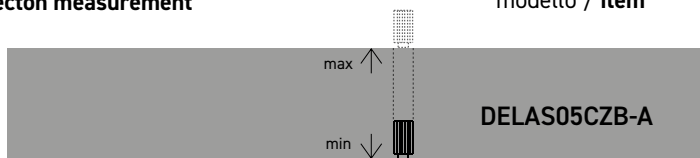
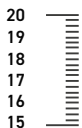

Lunghezza linea proiezione a terra
Ground projection line length

22 ÷ 31 mt

Spessore linea
Line thickness

9 ÷ 12 cm

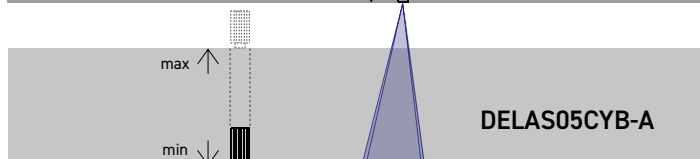
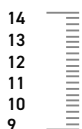

Lunghezza linea proiezione a terra
Ground projection line length

17 ÷ 28 mt

Spessore linea
Line thickness

5 ÷ 9 cm

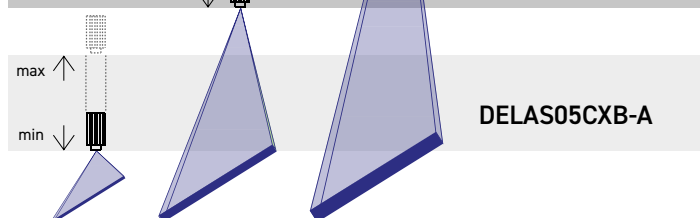
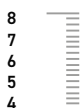

Lunghezza linea proiezione a terra
Ground projection line length

11 ÷ 23 mt

Spessore linea
Line thickness

3 ÷ 5 cm

Altezza di installazione
Installation height